

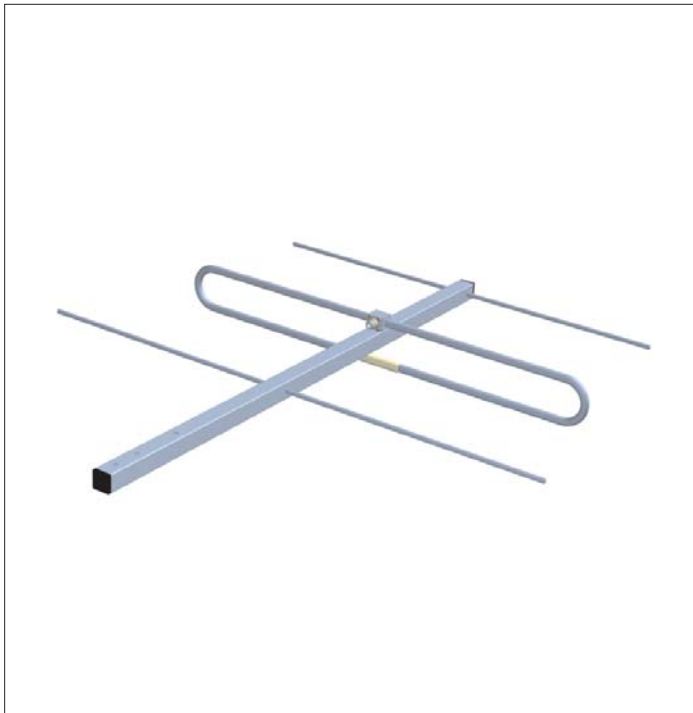

Directional Antennas

SA150.3



The antenna SA150.3 is designed for base radiostations working in bands of 150-162 Mhz. It can be used for receiving and transmitting till 200 W. The antenna has a directional radiation pattern, is broadband and that is why it is suitable for duplex operations.

Constructionally it is designed as a three-element YAGI, made of aluminium alloy and on the surface it is covered by polyester colour. During the lightning strike the antenna is protected by a galvanic connection with the tower. The wind resistance is 150 km/h.

The antenna is connected to the coaxial cable by the coaxial plug "N" type which is soled together with this antenna.

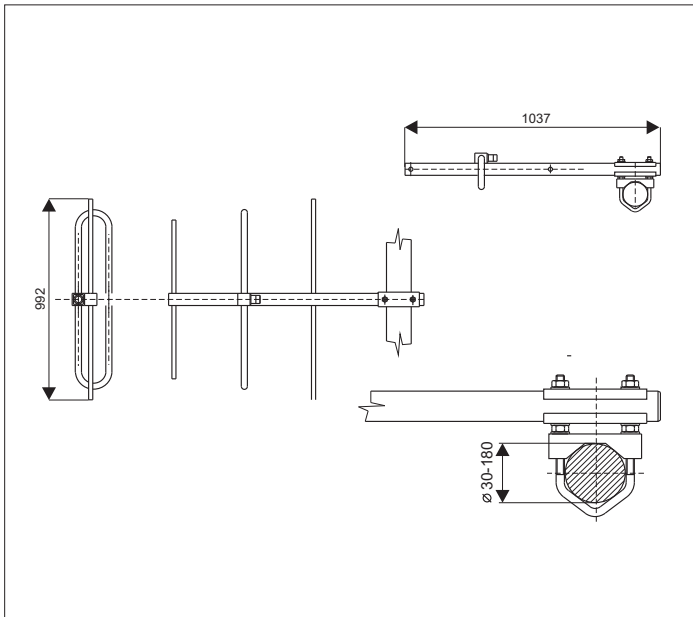

ELECTRICAL PARAMETERS

Frequency range [MHz]	150-162
Gain [dBd]	5.2-5.9
F/B ratio [dB]	min.20
Radiation angle in E-plane [°]	63-66
Radiation angle in H-plane[°]	102-114
VSWR	<1.8
Polarization	Vertical
Impedance [Ohm]	50
Max. Input power [W]	200
Antistatic protection	All metal parts DC-grounded (shows as DC-short)

MECHANICAL PARAMETERS

Connection	N female
Wind Surface/ with 15 mm icing [m²]	0.064 / 0.180
Wind Load/ with 15 mm icing [N]	103 / 287 @ 150 km/h
Length Boom/Driver [mm]	1037 / 840
Weight [kg]	2.0
Mouting	Supplied with mast bracket suiting 30-76 mm dia.mast

RADIATION PATTERNS

E-plane	032EA05
H-plane	014KA00

Radiation Patterns code is generated with VASSTOOL software

SWR SA150.3

